

Disney Castle

3D Puzzle



Ravensburger Verlag GmbH
Postfach 2460 · D-88194 Ravensburg · www.ravensburger.com

Distr. CH: Carlit + Ravensburger AG
Grundstr. 9 · CH-5436 Würenlos

Ravensburger



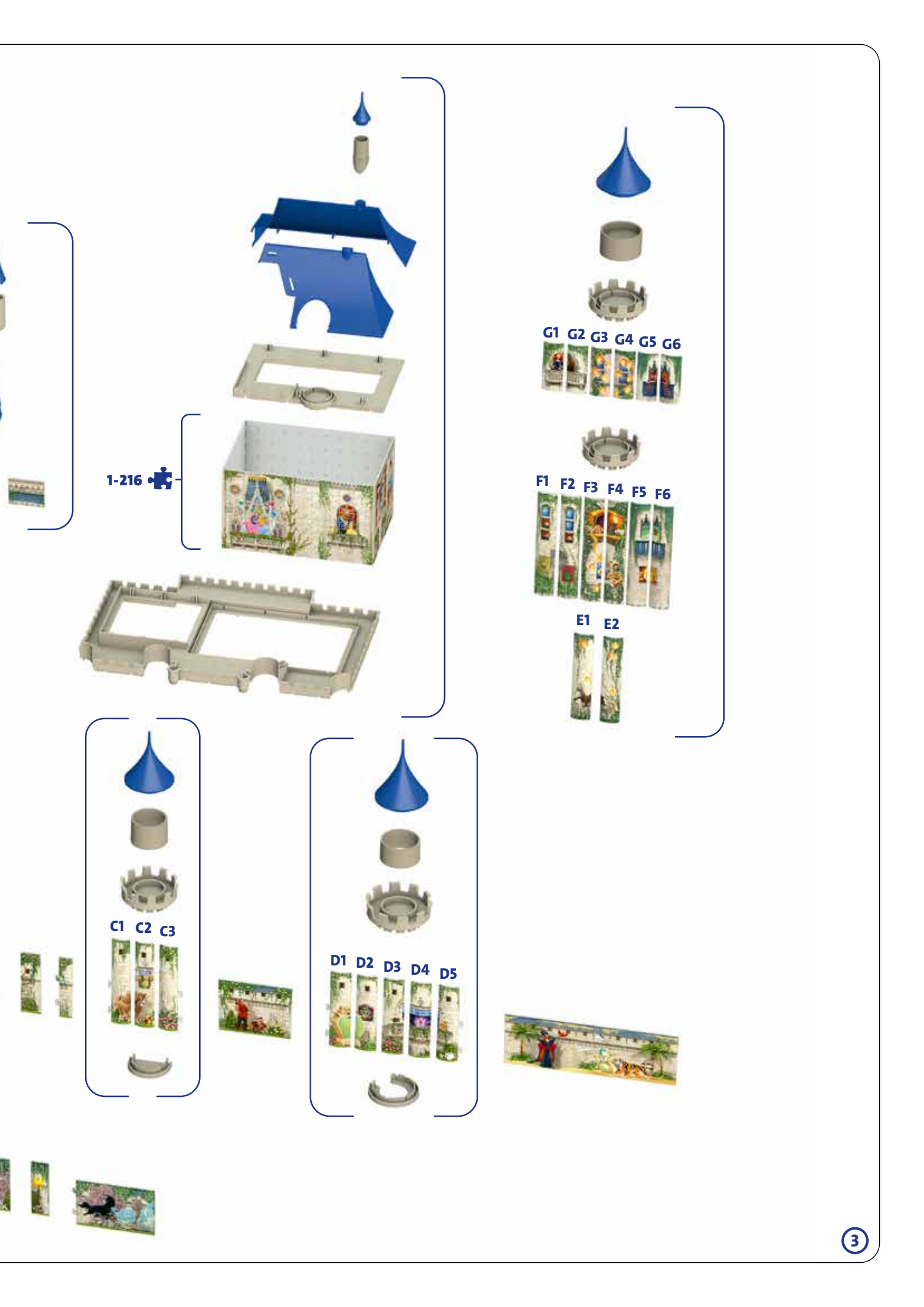

1-216 

G1 G2 G3 G4 G5 G6

F1 F2 F3 F4 F5 F6

E1 E2

C1 C2 C3

D1 D2 D3 D4 D5

A

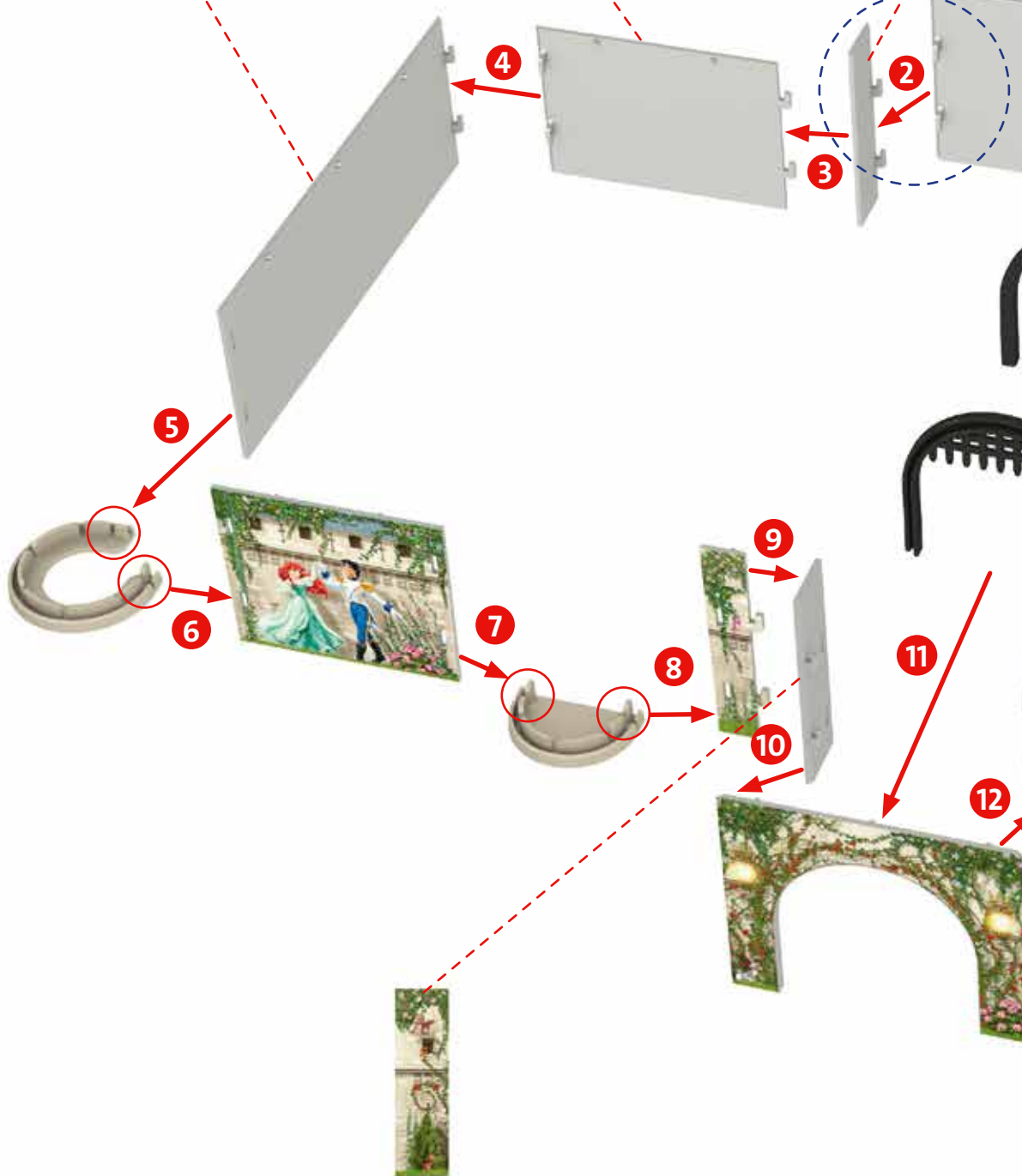

4

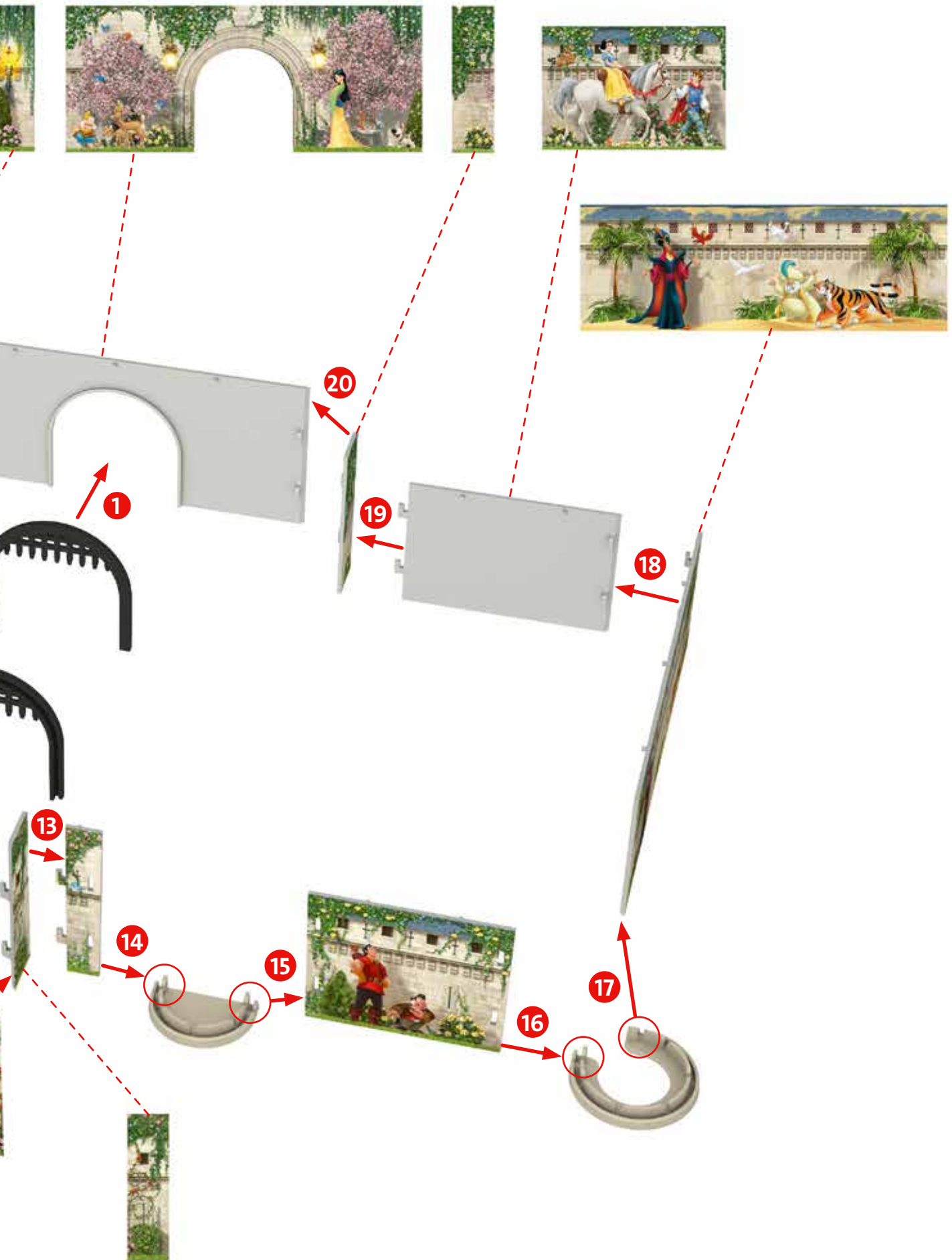

B

A1 A2 A3 A4 A5



B1 B2 B3



21



22



6

C1 C2 C3



D1 D2 D3 D4 D5

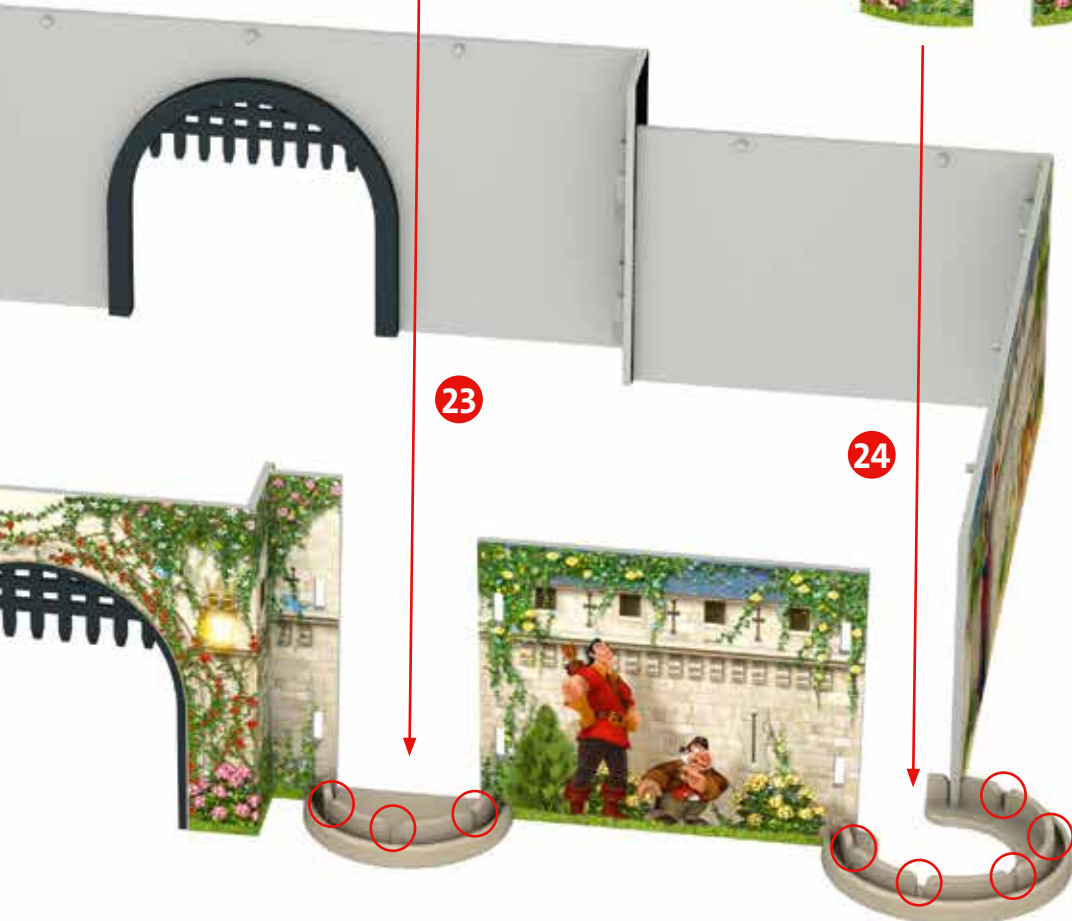

23

24

C

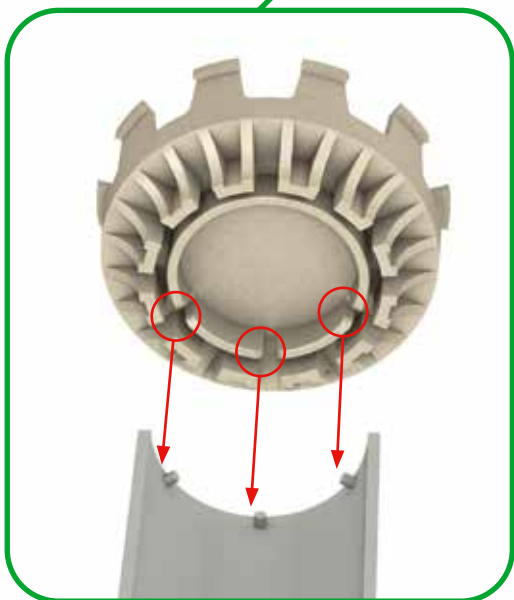
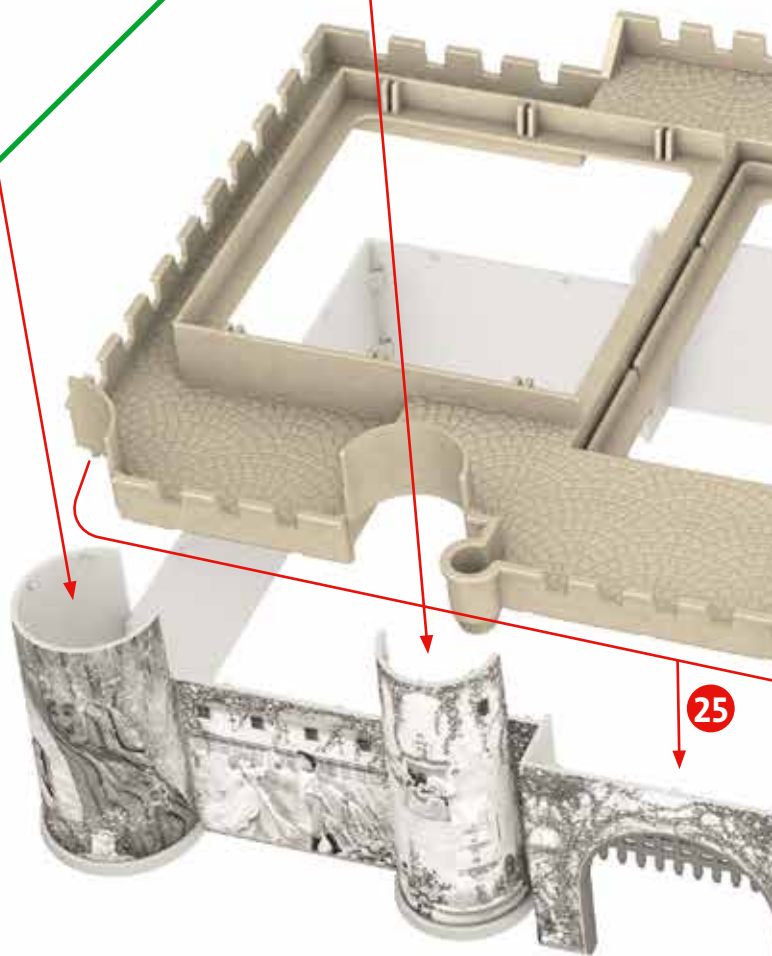
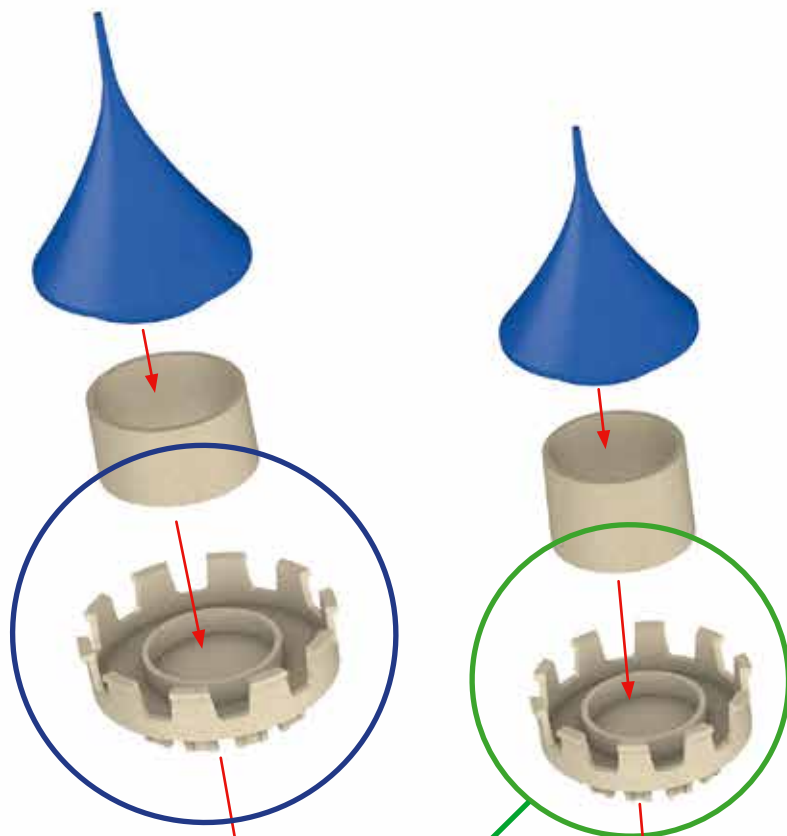

8

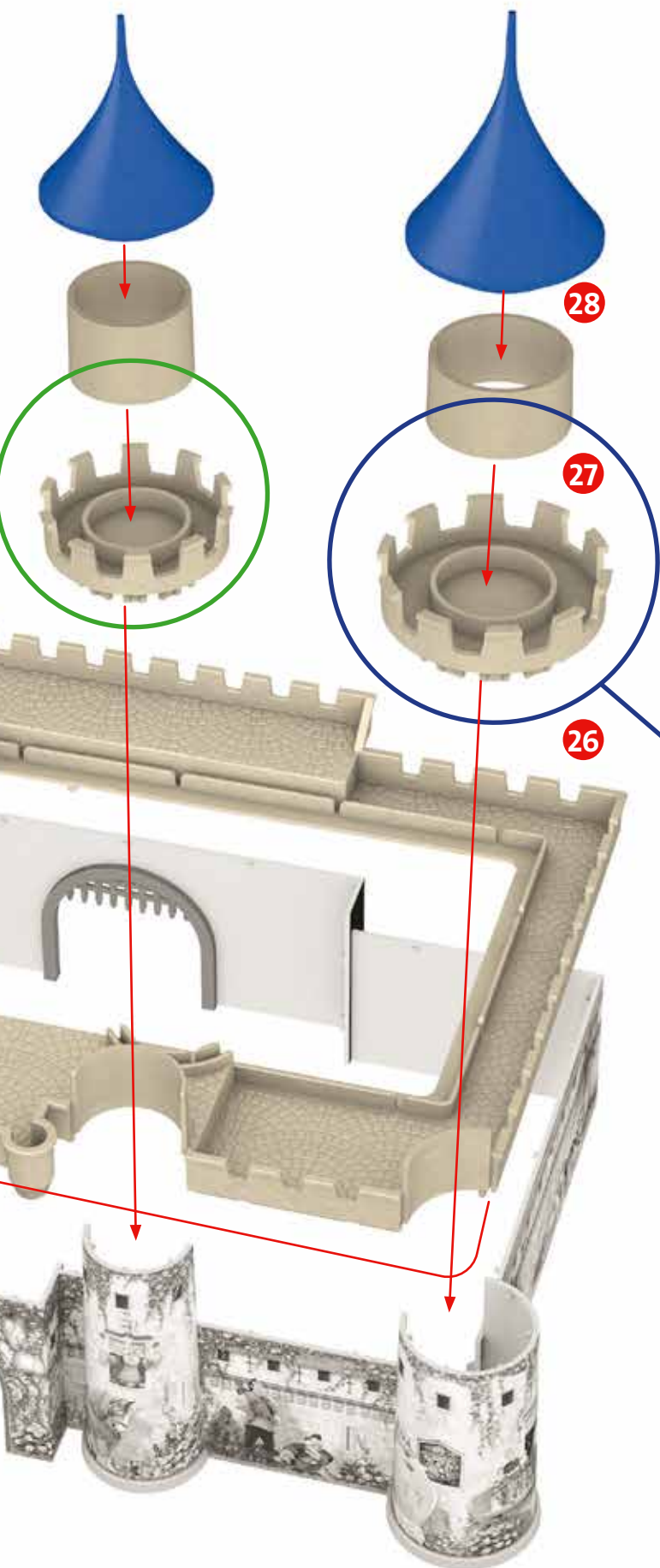

28

27

26

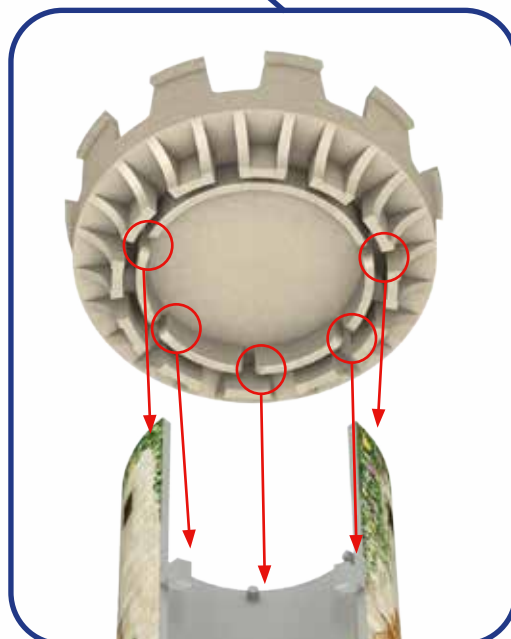

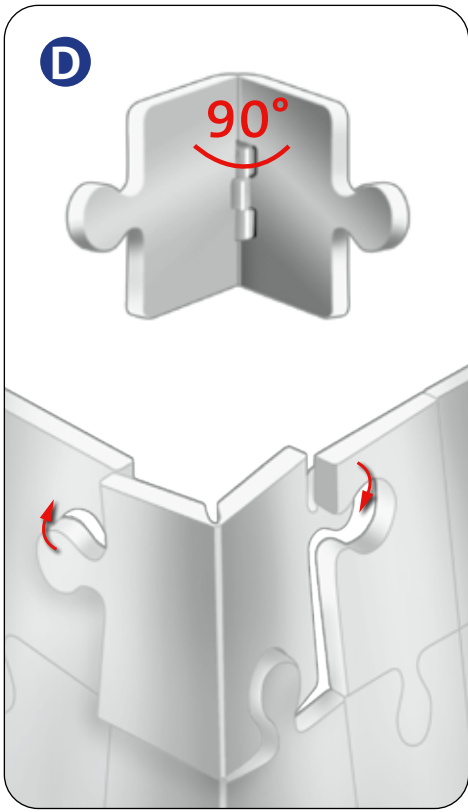



E

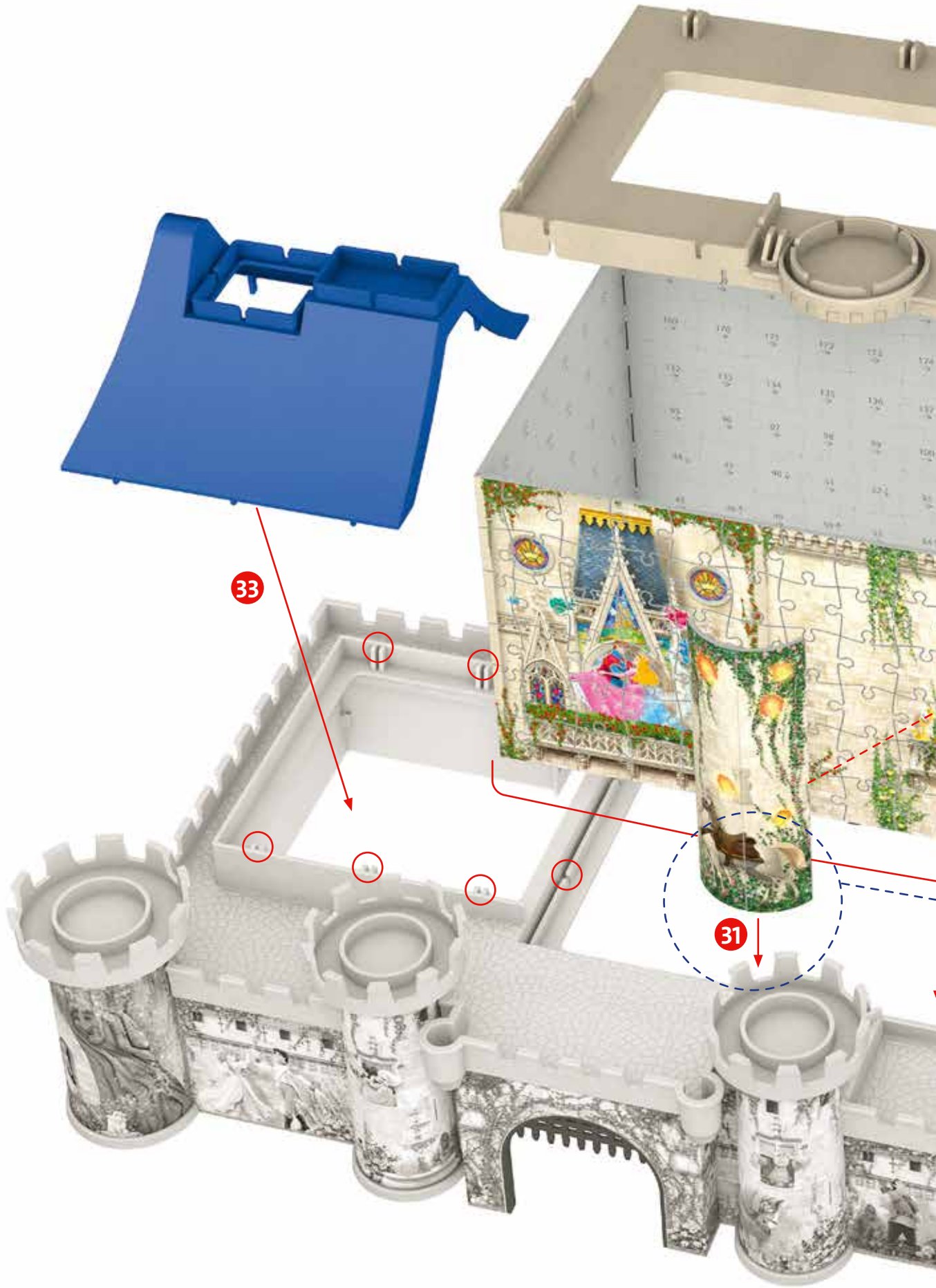



E1

E2

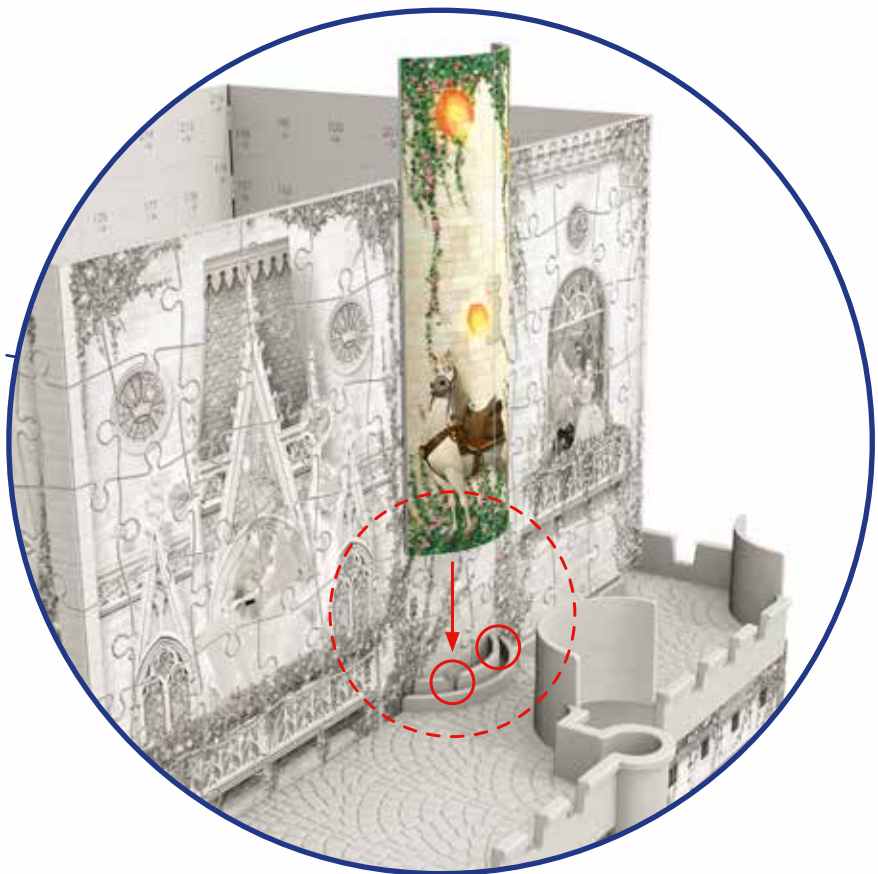

F

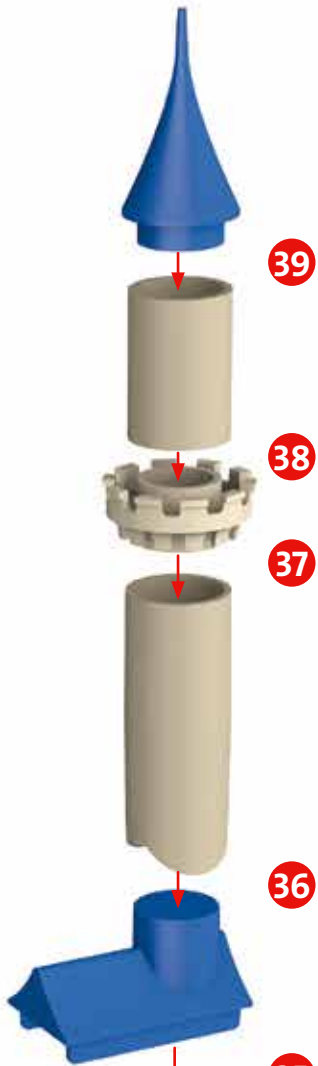

34

G



42

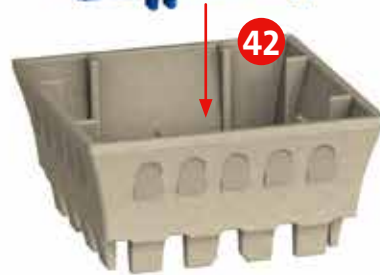

41



40

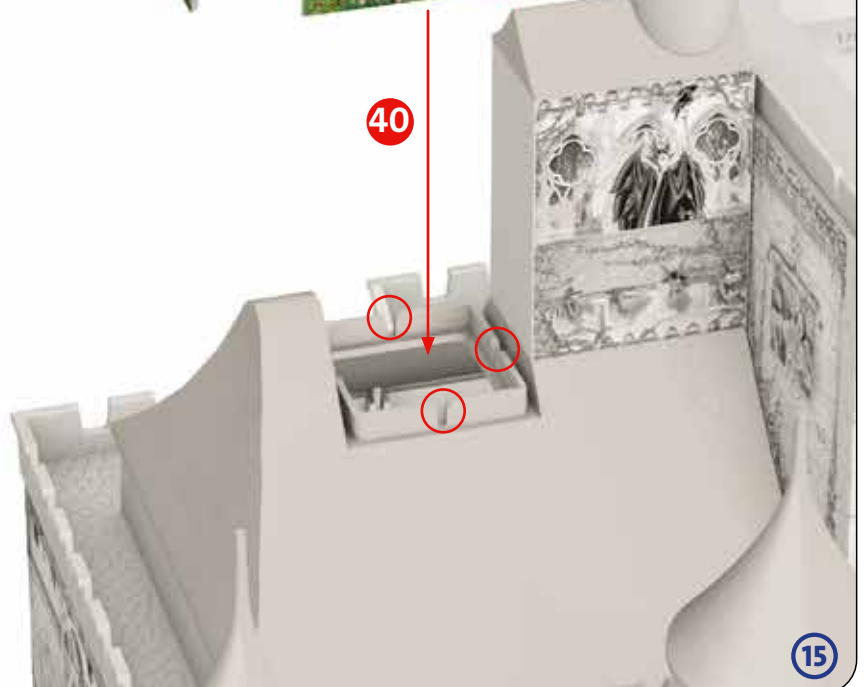

H

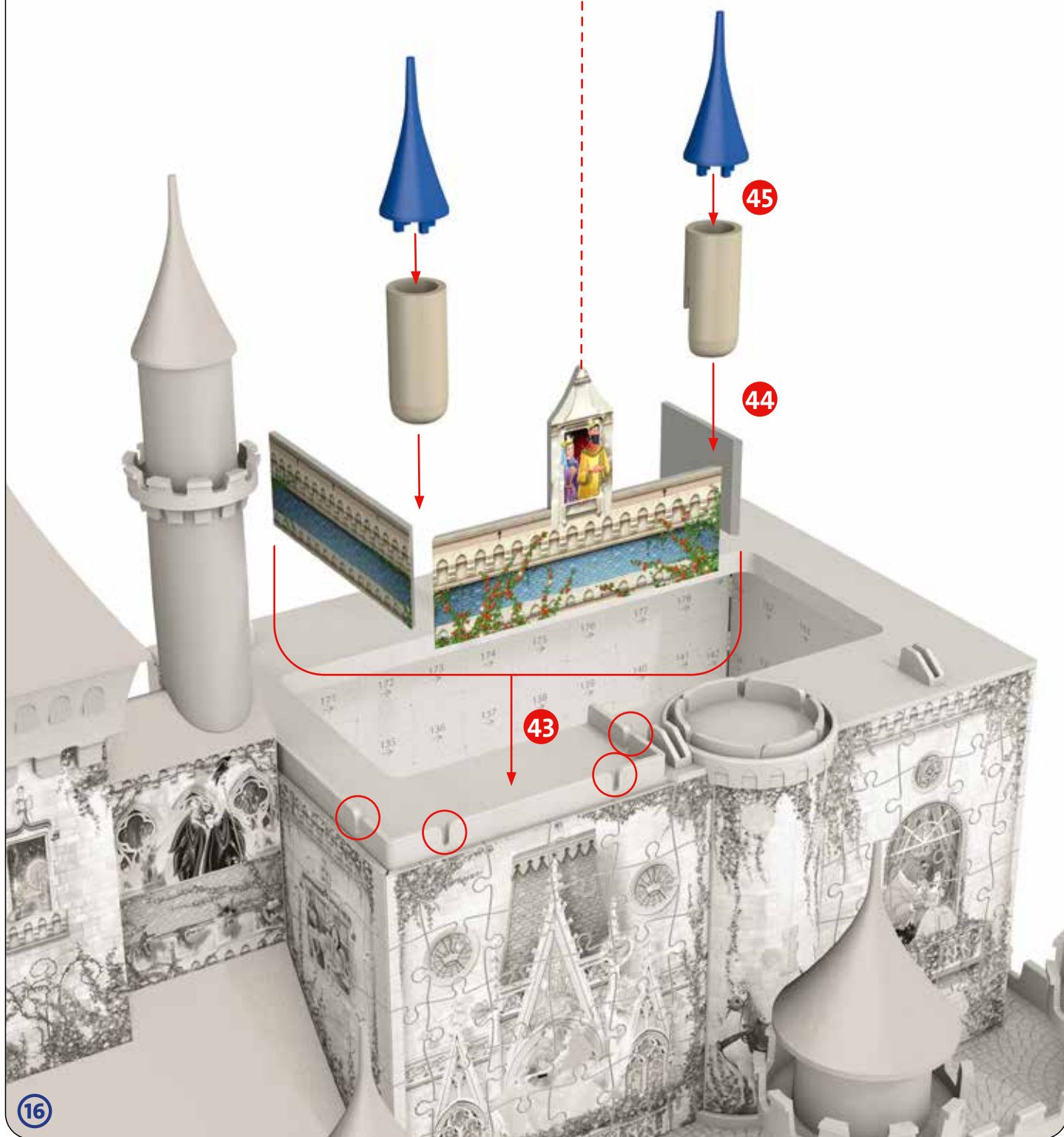

I

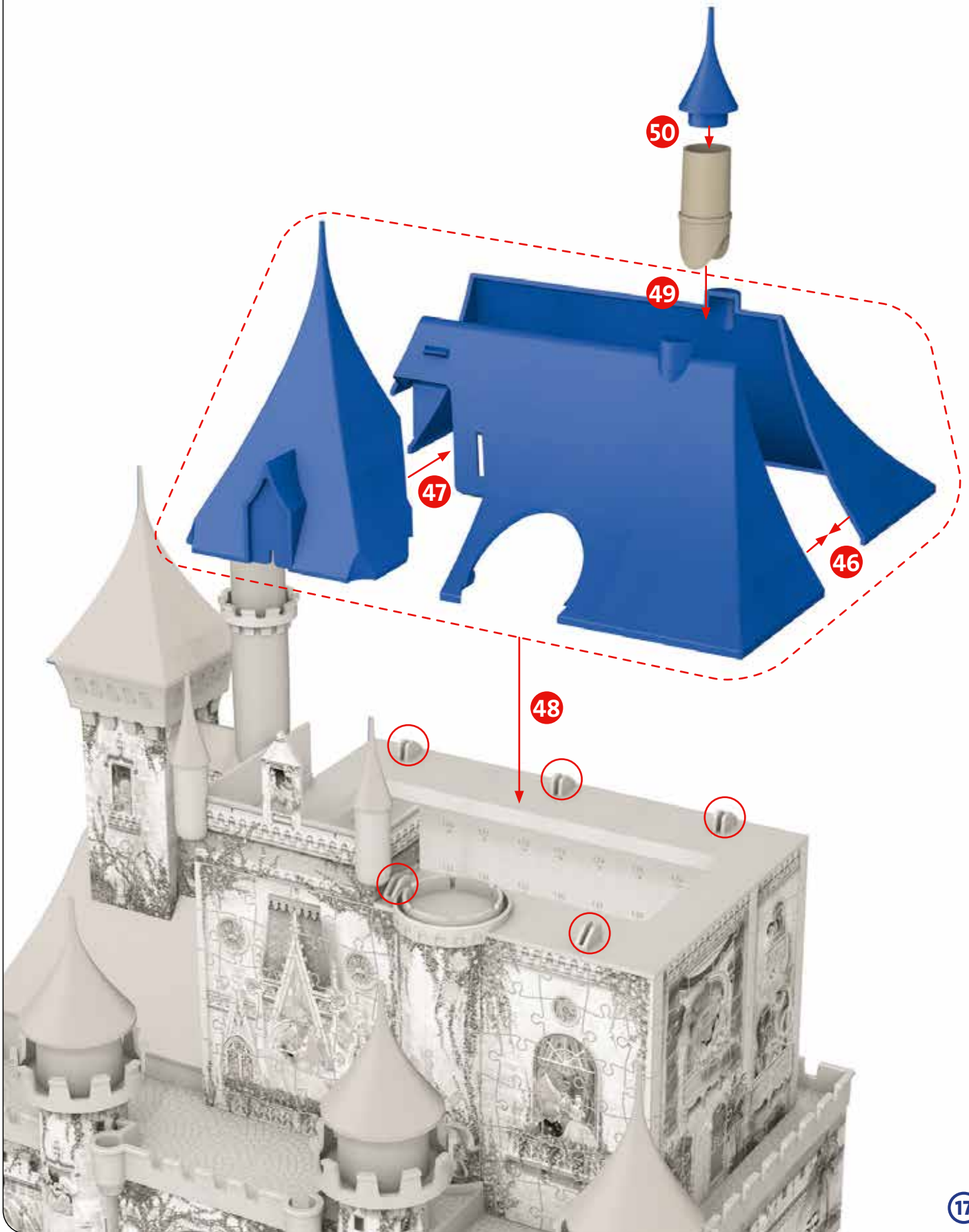

J

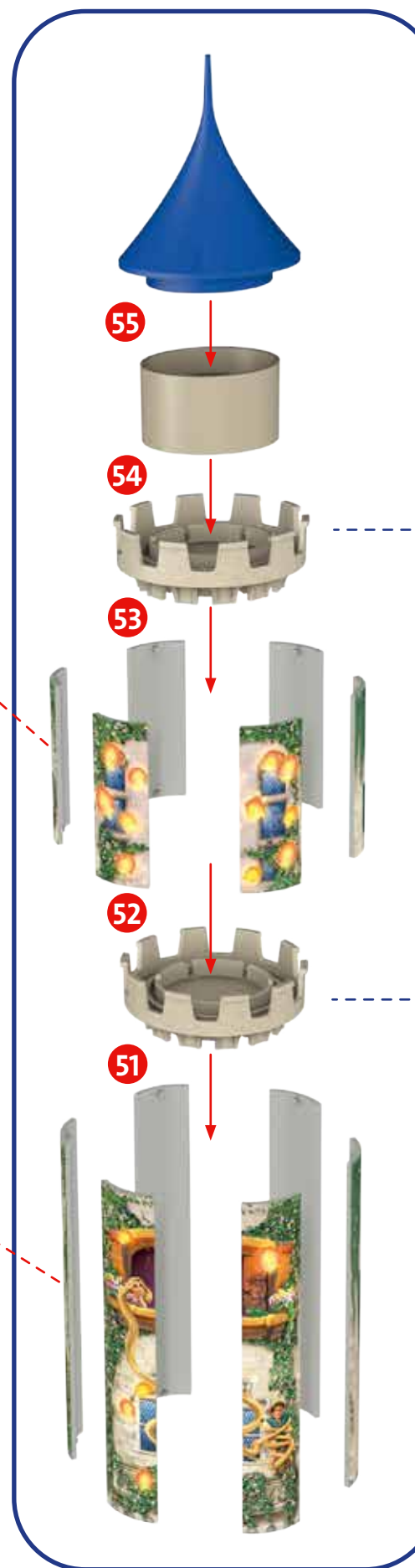

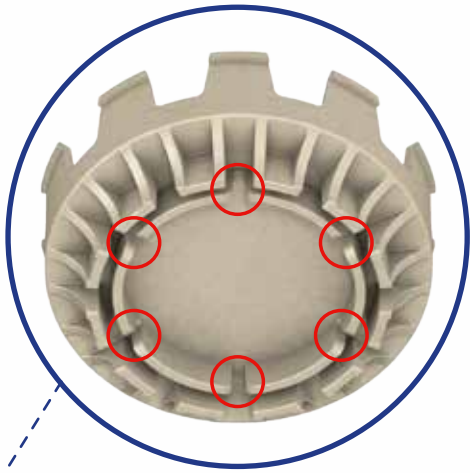

56



3D

Puzzle

